



**MODEL 811**

**10 TON BODY AND FRAME  
REPAIR KIT**

**USER'S MANUAL**

## FOR YOUR SAFETY

Read all instructions, warnings and cautions carefully. Follow all safety precautions to avoid personal injury or property damage during system operation. Jackco cannot be responsible for damage or injury resulting from unsafe product use, lack of maintenance or incorrect product and/or system operation. Contact Jackco when in doubt as to the safety precautions and operations.

Failure to comply with the following cautions and warnings could cause equipment damage and personal injury.

### **WARNING**

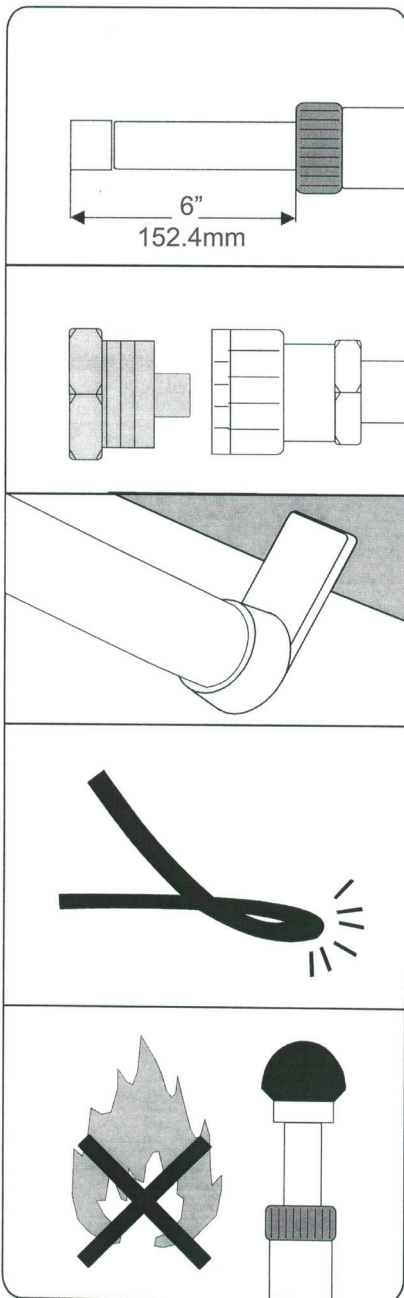

#### Ram Load

Never lift a load that exceeds the capacity of the ram. Do not over extend the ram, because it is possible to force the plunger out of the top of the ram.

#### Dust Caps

When coupler valves are disconnected screw in dust cap to keep the oil line clean.

#### Off-center loads

Be careful when load is not centered on ram plunger. Pump carefully- IF YOU FEEL THAT YOU HAVE TO PUMP UNUSUALLY HARD-STOP. Adjust set-up to the off center load is reduced.

#### Protect your hose

Do not drop heavy objects on your hose and avoid sharp kinks. Provide proper clearance to avoid damage to the hose and couplers.

#### Heat and fire

Always keep your equipment away from excessive heat or fire.

## **INSTRUCTION**

How to operate

Release Valve

Turn knob **CLOCKWISE** and pump handle for applying pressure.

Turn knob counterclockwise to release pressure.

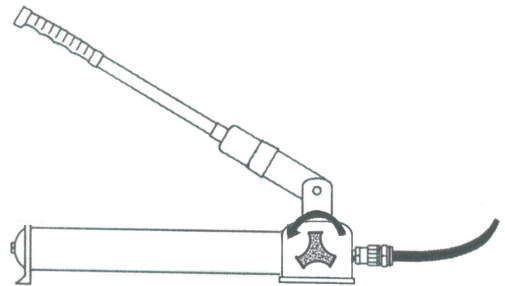
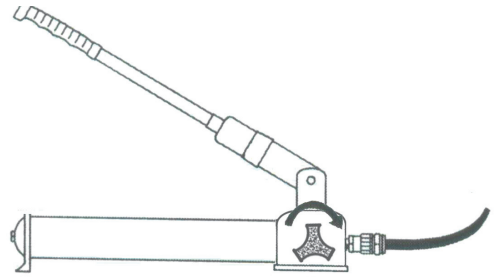

Pump Position

It is possible to hold pump in any possible from horizontal to vertical but always keep the hose end of the pump down when above the horizontal position

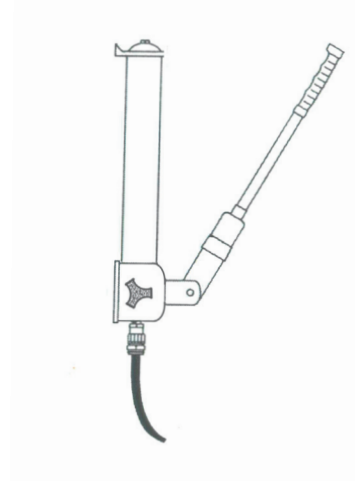
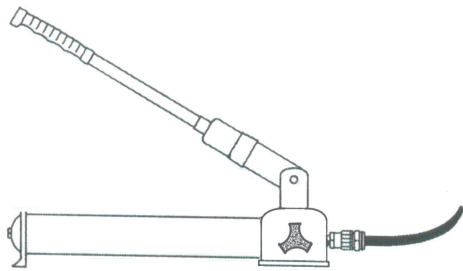

Oil Level

Retract the ram that is connected to the pump. Place pump in an upright position as shown. Remove filler plug and add hydraulic oil until it is level with the full mark on the dip stick.

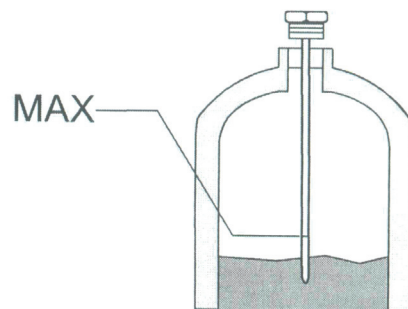

## Set Up

Possible configurations for the 10 ton ram and attachments.

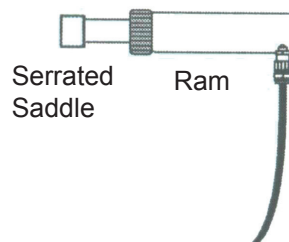
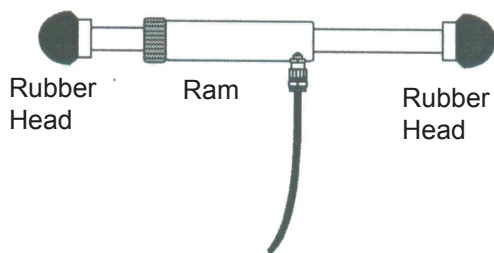
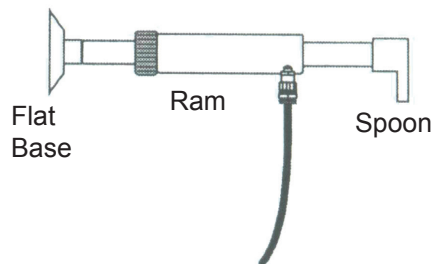
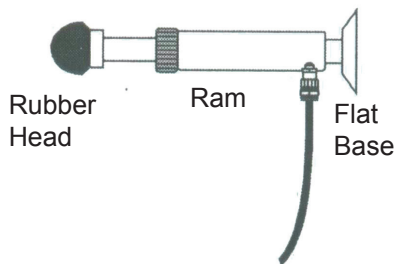
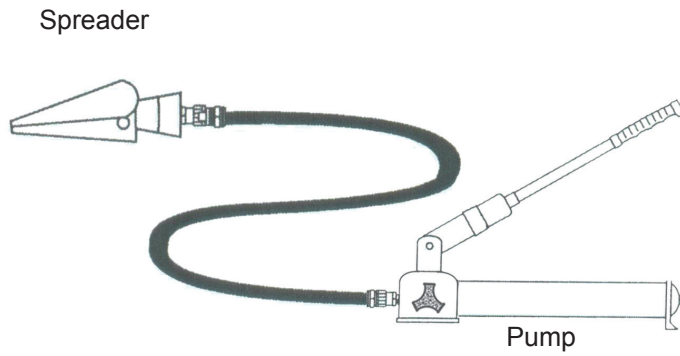
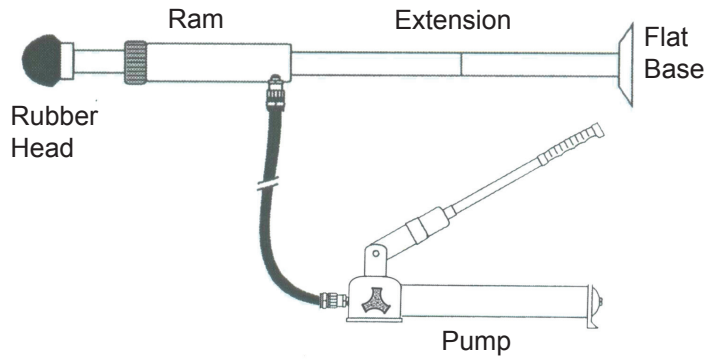

## Load Capacities

The capacity of this equipment is significantly affected by the number of attachments used and the type of load supplied. Several typical hook-ups are illustrated below. The approximate load capacity for each set-up is noted with illustration. When using two or more extension tubes together, always position the shortest tube farthest away from the ram.

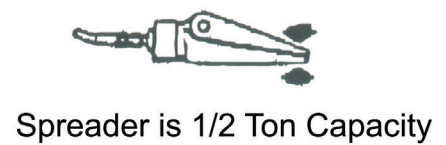
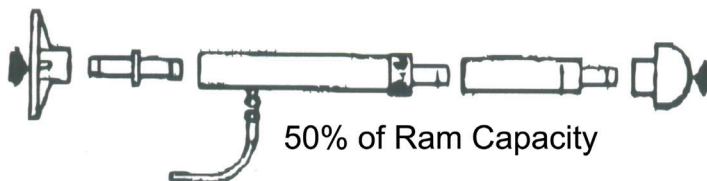
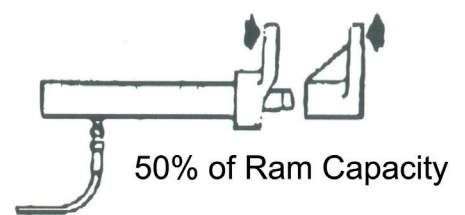
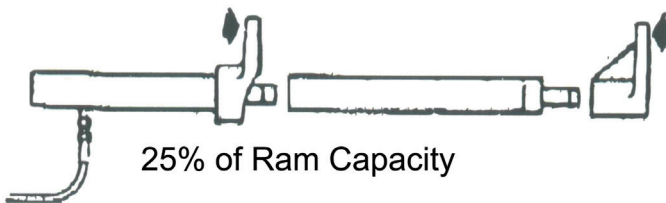
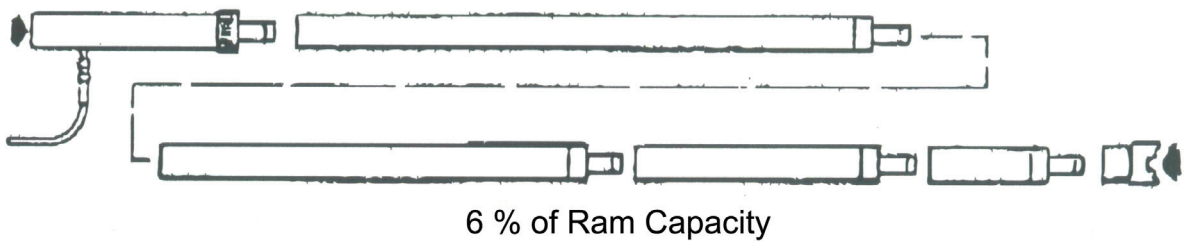
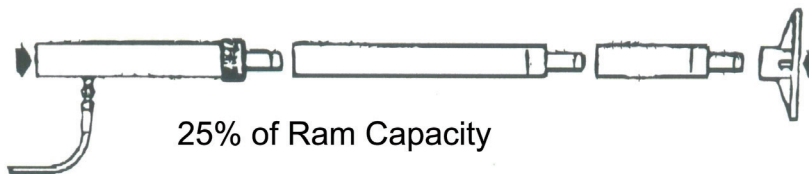
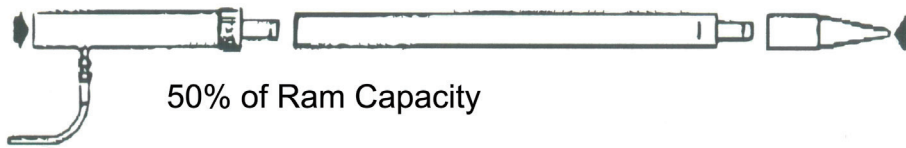
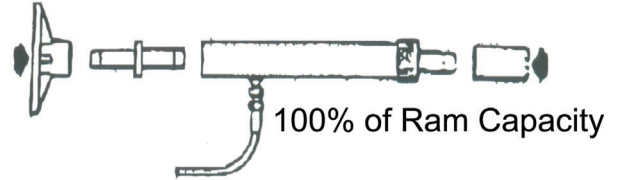
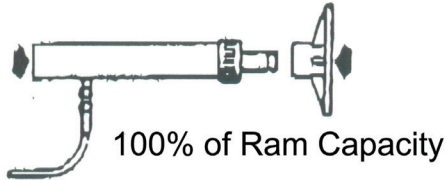

# Parts List

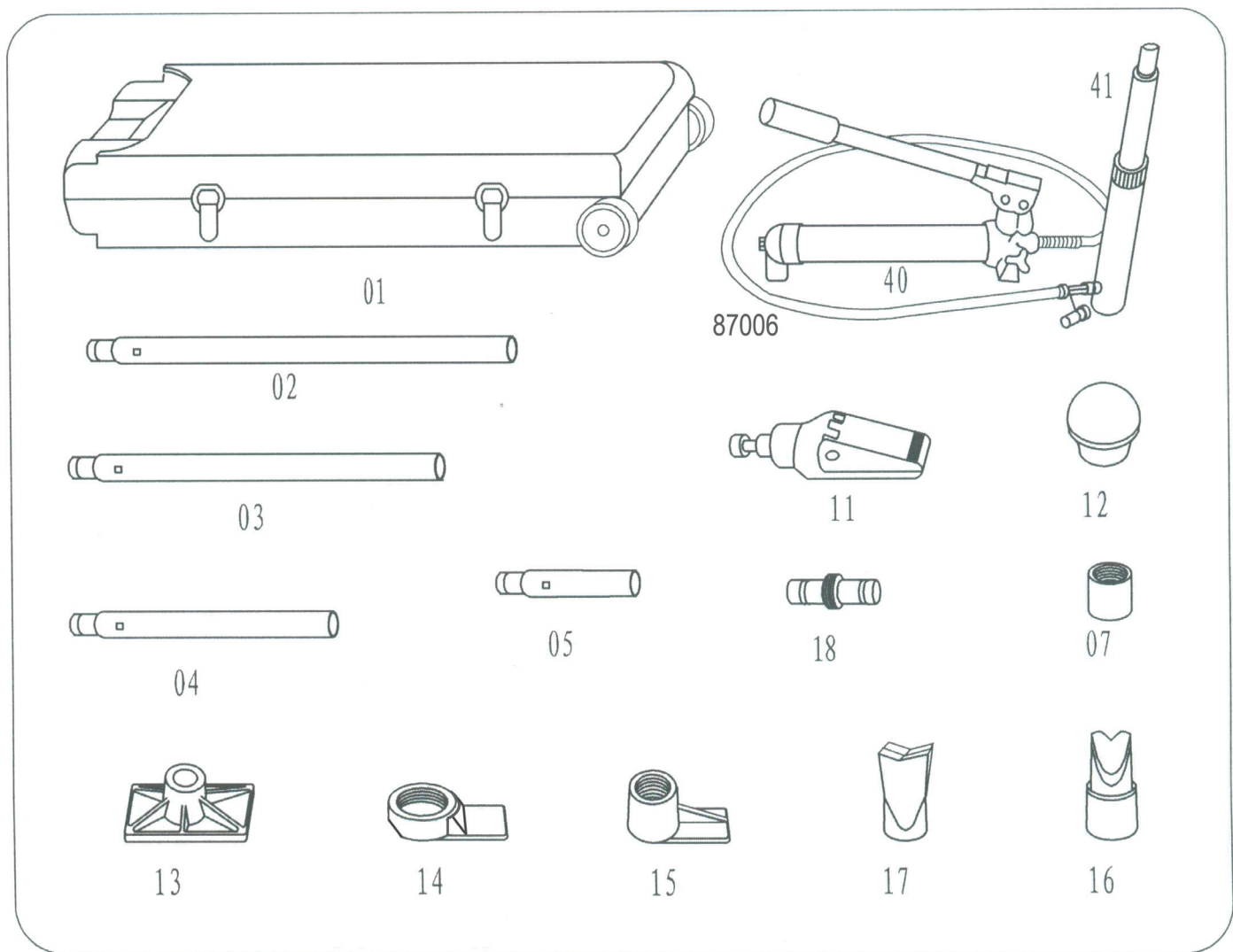

Part No.	Description	Q'ty
811-01	Blow Mold Case	1
811-A02	24" Extension Tube	1
811-A03	21" Extension Tube	1
811-A04	10" Extension Tube	1
811-A05	5" Extension Tube	1
811-07	Serrated Saddle	1
811-11	Spreader Ram	1
811-12	3 1/4" Rubber Head	1
811-13	Flat Base	1
811-14	Spreader Ram Toe	1
811-15	Spreader Plunger Toe	1
811-16	Wedge Head	1
811-17	90° V-Base	1
811-18	Lock on Connector	1
811-40	10 Ton Hydraulic Unit	1
811-41	10 Ton, 6" Stroke Ram	1
87006	6 ft. Hose With Half Coupling	1

# Hydraulic Spreader Assembly 1/2 Ton Capacity

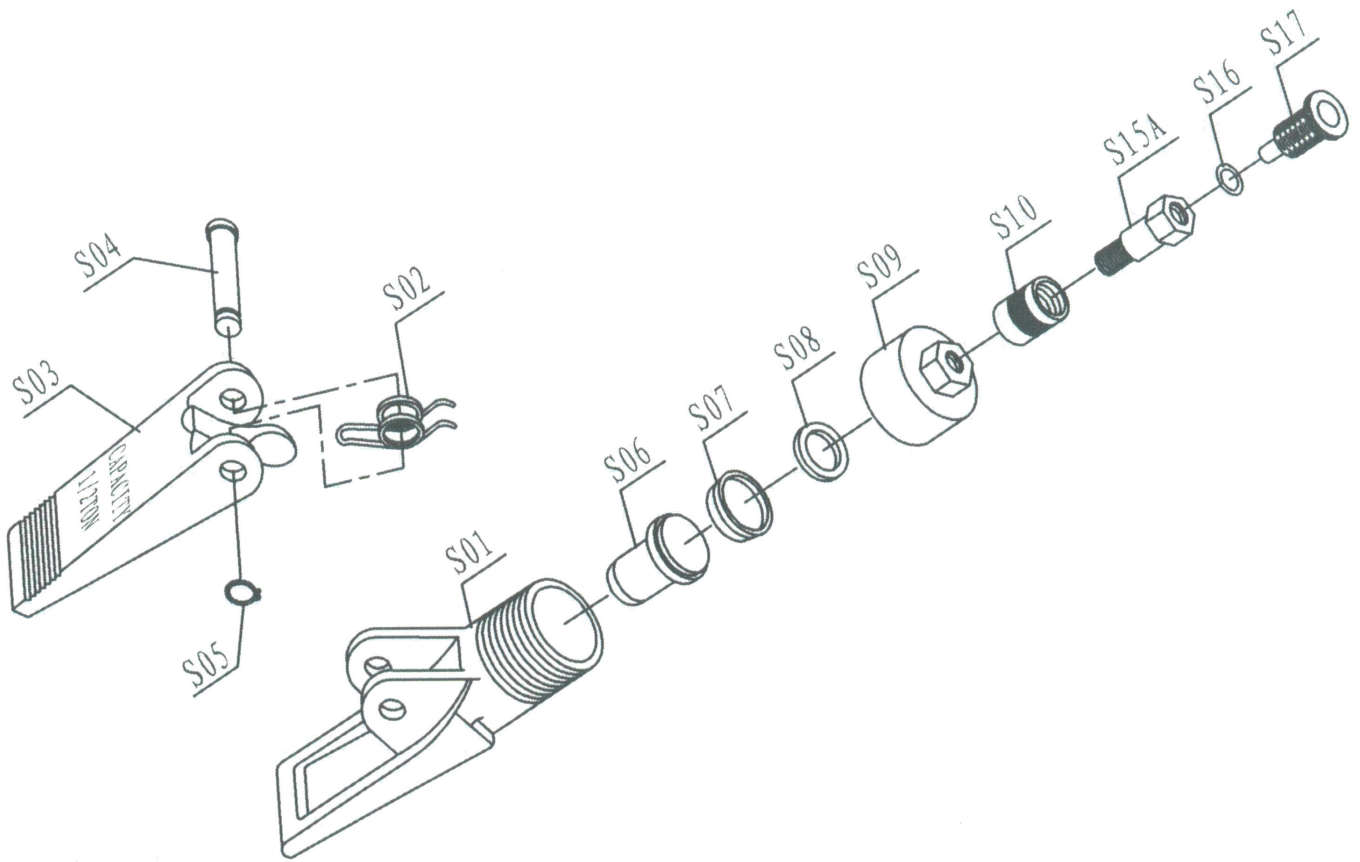

Part No.	Description
11-S01	Lower Duck Bill
11-S02	Spring
11-S03	Upper Duck Bill
11-S04	Pivoting Pin
11-S05	Cir Clips
11-S06	Piston
11-S07	Cup Seal
11-S08	Washer
11-S09	End Cap
11-S10	Coupling Ring
11-S15A	Couping Bolt
11-S16	Bolt O-Ring
11-S17	Dust Cap

# Hydraulic Ram Assembly 10 Ton Capacity

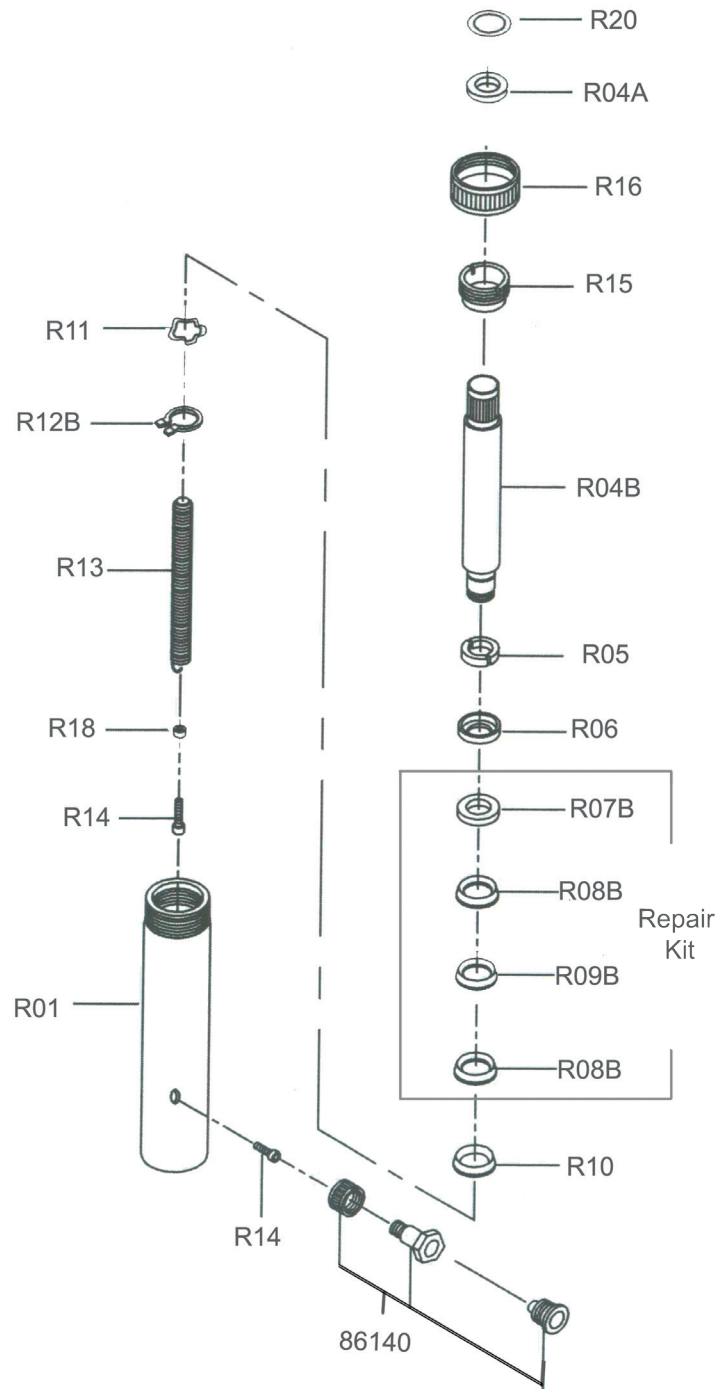

Part No.	Description	Part No.	Description
811-R01	Cylinder	811-R12B	Snap-Ring "C"
811-R04B	Ram	811-R13	Spring
811-R04A	Bearing	811-R15	Ring
811-R05	Bearing	811-R16	Protecting Cap
811-R06	Bushing	811-R14	Screw
811-R07B	Cap Ferrule(C2600p)	811-R18	Bushing
811-R08B	V Seal (Uletan)	811-R20	Ring "C"
811-R09B	V Seal (SS400)	86140	1/4" hydraulic coupler
811-R10	Spreader		
811-R11	Washer		

**Note:** Model: 81041RK-Seal Repair Kit contains : 811-R07B, R08B, R09B



# Hydraulic Body&Frame Pump 10 Ton Capacity

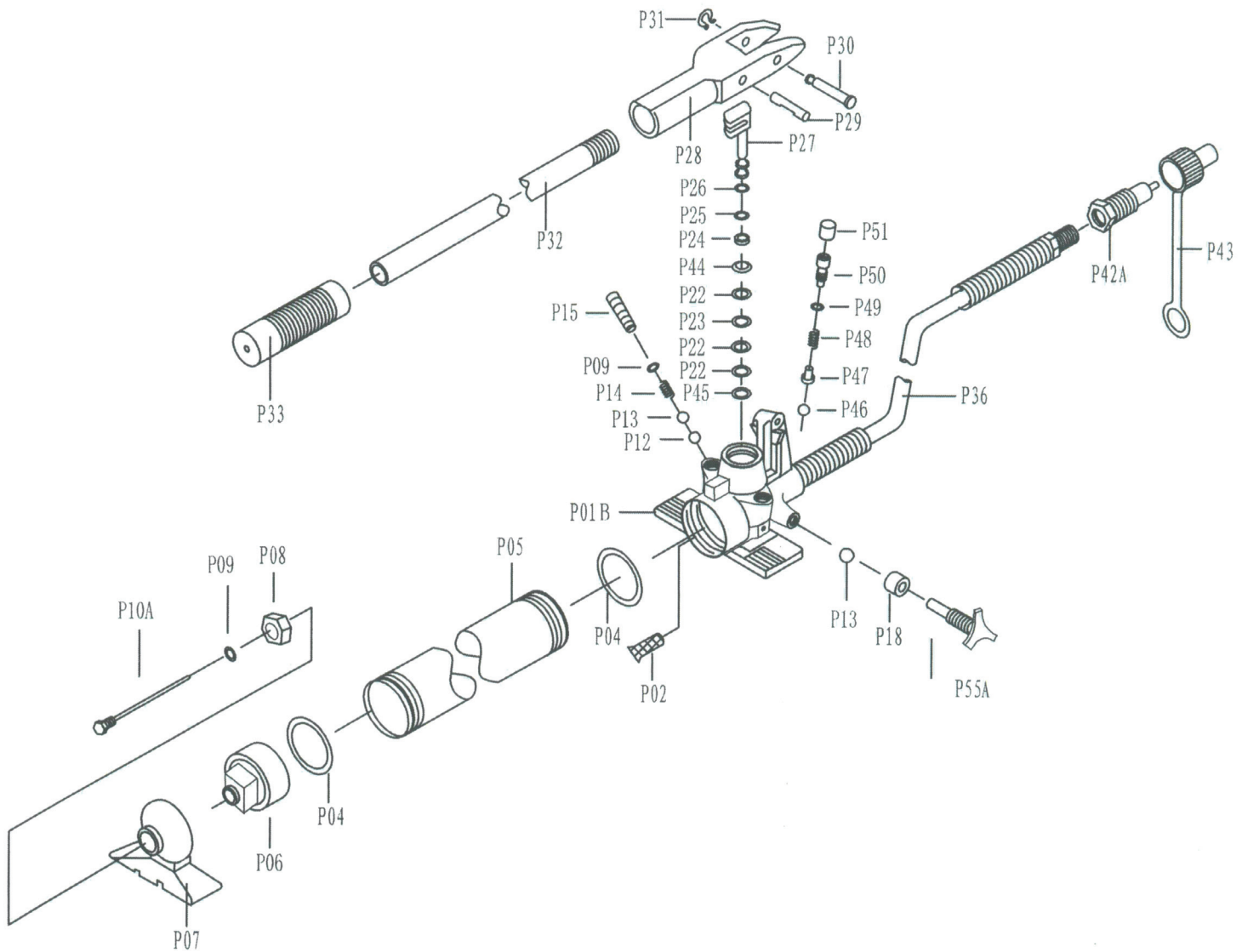

Part No.	Description	Part No.	Description
11-P01B	Pump Housing	11-P27	Plunger
11-P02	Filter	11-P28	Pump Pivot Brm Arm
11-P04	Seal	11-P29	Pivot Arm Pin
11-P05	Pump Reservoir	11-P30	Pivot Arm Pin
11-P06	Reservoir End Cap	11-P31	Cir Clip
11-P07	Pump Foot	11-P32	Pump Handle Assy
11-P08	Nut-Housing	11-P33	Grip
11-P09	O-Ring	11-P36	Hose
11-P10A	Dip Stick(Oil Level CK)	11-P42A	Coupling
11-P12	Ball Valve	11-P43	Dust Cap
11-P13	Ball Valve	11-P44	Back-up Ring
11-P14	Spring	11-P45	Back-up Ring
11-P15	Overload Stem	11-P46	Steel Ball
11-P18	Spacer	11-P47	Spring Plunger
11-P22	Seals (Complete Set)	11-P48	Spring
11-P23	Seal	11-P49	O-Ring
11-P24	Lower Spanner Nut	11-P50	Screw (Safety Valve)
11-P25	Seal	11-P51	Plastic Cap
11-P26	Upper Spanner Nut	11-P55A	Release Valve Stem

#### **LIMITED ONE YEAR WARRANTY**

Jackco Transnational Inc. warrants all Jackco equipment and tools to the original purchaser against any manufacturing defect in material or workmanship for a period of one (1) year from the original date of purchase. If the defective equipment or tool is determined to be covered under this warranty, it shall be repaired or replaced at manufacturer's discretion without charge, provided that the equipment or tool must be returned with proof of purchase to the dealer and freight prepaid, if returned to the manufacturer. This warranty shall not apply to damage due to accident, negligent use, and lack of maintenance, abuse or applications other than the specific function the equipment or tool is designed for.

No other warranties, expressed or implied, including those of merchantability or fitness for particular purpose shall be applicable to Jackco except as specifically stated herein. In no event shall Jackco be liable to any party for any special, direct, indirect, consequential, punitive damage of any nature caused by the sale or use of the equipment or tool.

Note: This warranty gives the original purchaser specific legal rights which may vary from state to state.

Jackco Transnational Inc. © 2009  
888-452-2526 [www.jackco.com](http://www.jackco.com)